

KISTOCK DATALOGGER HVAC range : KTH-CO₂-E

Temperature / Humidity / CO₂

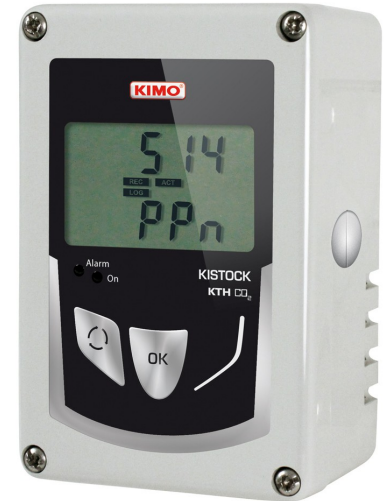

KEY POINTS

- 20 000 measurement points
- 2 configurable setpoint alarms
- Gas input for calibration
- Fast data download (1000 values per seconds)
- IP40 housing
- Supplied with 1 m of silicone tube

TECHNICAL FEATURES

Displayed units	°C, °F, %RH, °Ctd, °Ftd, ppm
Resolution	0.1°C, 0.1°F, 0.1%RH, 1 ppm
Setpoint alarm	2 setpoint alarms on each channel
Frequency of measurement	From 15 s to 24 h
Working temperature	From -20 to +70 °C
Storage temperature	From -40 to +85 °C
Battery life	3 years (on the basis of 1 measurement each 15 minutes at 20°C)

TECHNICAL FEATURE OF THE INTERNAL SENSOR

	Hygrometry	Temperature	CO ₂
Type of sensor	CMOS		NDIR
Measuring range	From 5 to 95 %RH	From -20 to +70 °C	From 0 to 5000 ppm
Accuracy*	Accuracy (Repeatability, linearity, hysteresis) : ±2%RH (from 15°C to 25°C) Factory calibration uncertainty : ±0.88 %RH Temperature dependence : ±0.04 x (T-20) %RH (if T<15°C or T>25°C)	From -20 to 0°C : 2% of reading value ±0.6 °C From 0 to 30 °C : ±0.5 °C From 30 to 70 °C : 1.5% of reading value	±50 ppm +3% of reading value
Response time (t₆₃)	50 s (Vair = 2 m/s)	25 s (V = 2 m/s)	> 120 seconds (ambient use) > 20 s in forced gas generation ¹

*All accuracies indicated in this document were stated in laboratory conditions and can be guaranteed for measurements carried out in the same conditions, or carried out with calibration compensation.

FEATURES OF HOUSING

Size

120 x 80 x 55 mm

Weight

250 g

Display

2 lines LCD screen

Size : 45 x 28.5 mm

Control

2 buttons : Select and OK

Material

ABS housing

Protection

IP 40

PC communication

1 input for male Jack connector 3.5

European directives

2004/108/EC EMC

2006/95/EC Low Voltage

2011/65/EU RoHS II

2012/19/EU WEEE

Battery power supply

Type lithium 3.6 V

Visual alarm

2 electroluminescent diodes (green and red)

Environment

Air and neutral gases

PC CONNECTION

Input for PC connection

Jack connector (3.5)
Input for Kistock-PC software

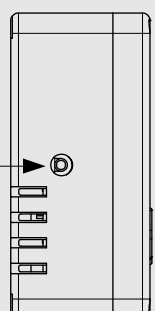

RECORDER FUNCTIONS

Five recording modes

KISTOCK can record in five different ways :

- **“Immediate”** mode records values according a predefined interval.
- **“Minimum”**, **“Maximum”** and **“Average”** record automatically the calculation of minimum, maximum and average of measured values during an interval recording.
- **“Monitoring”** mode allows to get an accurate history report during error events to help troubleshooting, without stopping the measurement logging. To proceed this way, you just have to define :
 - a record interval to be used whilst the reading are beyond the setpoints
 - a record interval for the values measured during each reading beyond the setpoints.
 Furthermore, you can also let your KISTOCK record non-stop (“loop” recording option).

Four types of dataset start

Once your recording mode has been set, you can launch your dataset :

- With a delayed start (with predefined date and time)
- With the software
- With push-button
- With **“Online”** option. In this case, your datasets are directly sent, saved and displayed on your PC in real time.

Six types of dataset stop

You can stop your dataset :

- According to a date and time (if it was started the same way)
- According to a period
- According to a predefined number of recording points
- Once the storage capacity is full
- With **“Stop”** option of the software
- By holding **“OK”** key for at least if this function has been previously activated by the software.

SIZE (in mm)

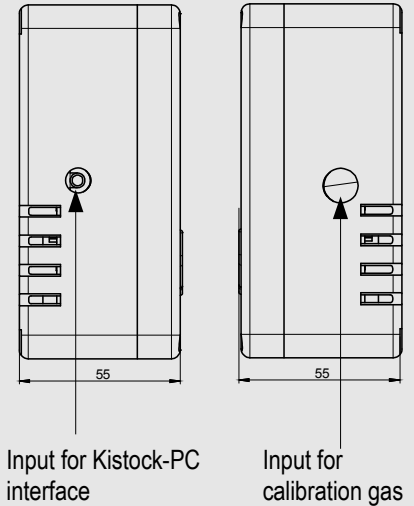
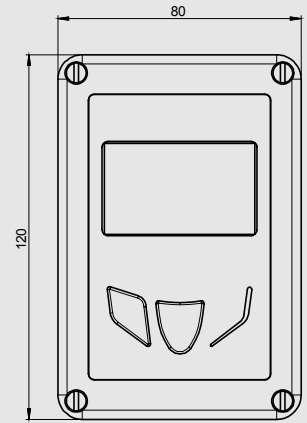

DISPLAY

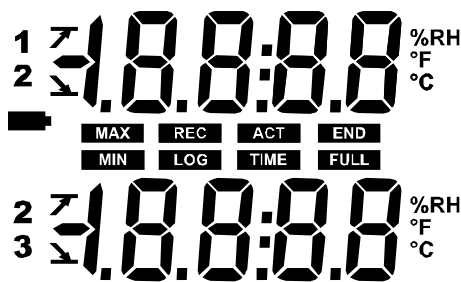

°C.. Temperature in degree Celsius
 °F.. Temperature in degree Fahrenheit
 %RH...Relative Humidity
 ppm : concentration of CO₂ in ppm

- END** Dataset is finished
- REC** One value is being recording
- LOG** Flashing : dataset has not started yet
Constant : data set is in progress
- FULL** Slow flashing : dataset is taking 80-90% of storage capacity
Fast flashing : dataset is taking 90-100% of storage capacity
Constant : storage capacity filled up

- ACT** Refresh of displayed measurement
- TIME** Display of measurement and recording intervals
-  Low battery indicator
- MIN** Displayed values correspond to maximum and minimum values of the channels
- MAX**

- 12** Channel No. which is measuring
- 23**

-  Alarm action type : rising or falling action

SOFTWARE



- Configuration and data processing software **KILOG** software enables you to configure, save and process your data in a very simple way.
- Software..... Ref. *KILOG-N*
- USB interface..... Ref. *I-KIC2*
- Complete set : software + 1 interface..... Ref. *KIC2 KILOG*



• **KILOG CFR software**

KILOG CFR software is the key tool for users who requires traceability, in accordance with 21CFR-Part11 standards. Security and integrity of data are guaranteed : it is not possible to modify or tamper with the data.

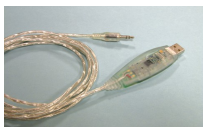

• **KISTOCK-PC interface**

This USB cable enables you to connect your KISTOCK to your PC..
Ref. *I-KIC2*

- Interface.....Ref. *I-KIC2*
- Complete kit : KILOG 1CFR software + 1 interface...Ref. *KIC2-CFR-N*



Software is compatible with the former range of Kistock.

ACCESSORIES



• **KNT data collector.**

KNT data collector allows you to collect measurements from one or several KISTOCK directly on-site (up to 500,000 values stored). Data can be displayed and printed from the KNT or download to your PC.
Ref. *KNT 310*

CALIBRATION

KISTOCK dataloggers can be supplied with calibration certificate as an option.

WARRANTY PERIOD

KISTOCK dataloggers have 1-year guarantee for any manufacturing defect (return to our After-Sales Service required).

PERFORM AN AUTOZERO

Follow this procedure to perform a checking of the KTH-CO₂-E :

- > Connect the KTH-CO₂-E to the kilog software to set the atmospheric pressure.
- > Launch a dataset with a 15 s measurements frequency.
- > Unscrew the screw on the right side of the datalogger.
- > Connect a bottle of CO₂ standard gas on the pressure connection of the KTH-CO₂ with the supplied silicone tube.
- > Generate a gas flow of 30l/h.
- > Wait for the stabilisation of the measurement, about 3 minutes for an optimum stabilisation
- > Read the values indicated by the KTH-CO₂-E.



FIXATION

With its fixing system by wallmounting,, it is possible to transport or fix the Kistock KTH-CO₂-E easily.

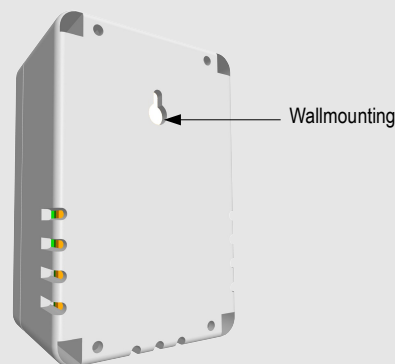

Wallmounting

PRECAUTIONS FOR USE

Please always use the device in accordance with its intended use and within parameters described in the technical features in order not to compromise the protection ensured by the device.

www.kimo.fr

Distributed by :



EXPORT DEPARTMENT

Tel : + 33. 1. 60. 06. 69. 25 - Fax : + 33. 1. 60. 06. 69. 29

e-mail : export@kimo.fr